

Multifunction Calibrator PCE-123



Features:

1. 4-20mA (1K Ω load, 24V Loop Supply)
2. 0-100.00mV,0-1.000V, 0-12.000V
3. K, J, E, T Thermocouple ($^{\circ}$ C and $^{\circ}$ F)
4. Frequency 1-62500 Hz
5. 0.025% Basic Accuracy
6. Easy Key-pad Operation
7. Easy Step and Auto Ramp Functions
8. 0-20mA, 0-24mA selectable
9. 0-100% Input (mA, mV, V)
10. Beeper warning when output is open (mA) or short (mV,V)

Table of Contents

I. PANEL DESCRIPTION	1
II. OPERATING INSTRUCTION	6
1. MA OUTPUT	6
1a. General Operation 4 - 20mA	6
1b. Select 0 - 20mA or 0 - 24mA	7
1c. Enter a value less than 1	8
2. MV, V OUTPUT	9
2a. General Operation 0 - 100mV	9
2b. Select 0 - 1V or 0 - 12V	10
2c. Enter a value less than 1	11
3. HZ, FREQUENCY OUTPUT	12
4a. General Operation	13
4b. Select °C, or °F	15
4c. Select K, J, E, or T type Thermocouple	17
4d. Enter a Negative Temperature	18
5. % INPUT IN THE MA, MV, V FUNCTIONS	19
6. EASY STEP IN THE MA, MV, AND V FUNCTIONS	21
7. AUTO RAMP IN THE MA, MV, AND V FUNCTION	23
8. HOW TO GET NEGATIVE OUTPUT	26
III. ELECTRICAL SPECIFICATION	27
IV. USE THE AC ADAPTER	32
V. USE EXTERNAL BATTERY PACK	33
VI. BATTERY REPLACEMENT	34

I. Panel Description

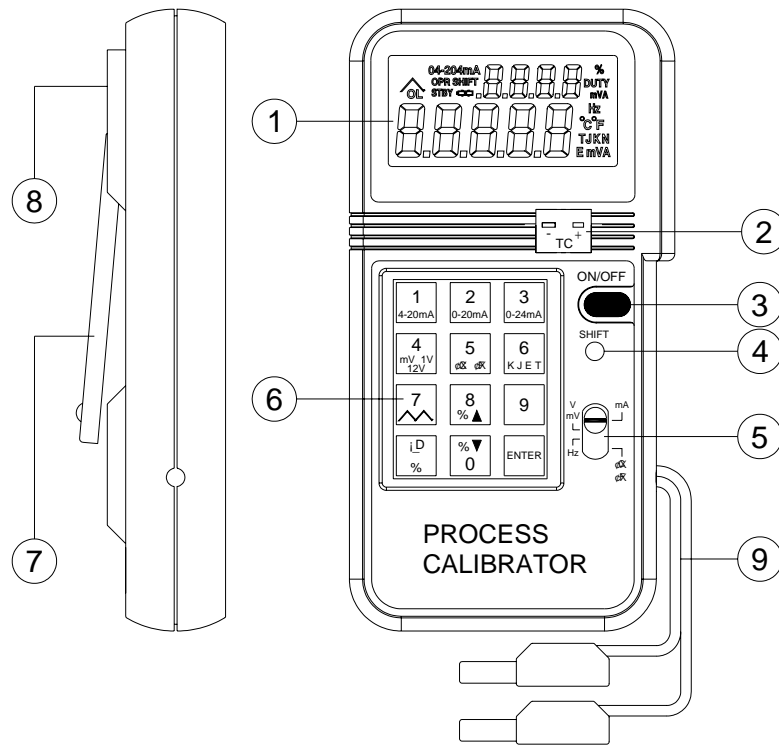

- | | |
|---------------------------|--------------------------------|
| 1. LCD DISPLAY | 6. NUMERICAL & FUNCTION KEYPAD |
| 2. THERMOCOUPLE SOCKET | 7. STAND |
| 3. ON/OFF BUTTON | 8. AC ADAPTOR INPUT SOCKET |
| 4. SHIFT BUTTON | 9. OUTPUT LEADS |
| 5. FUNCTION SELECT SWITCH | |

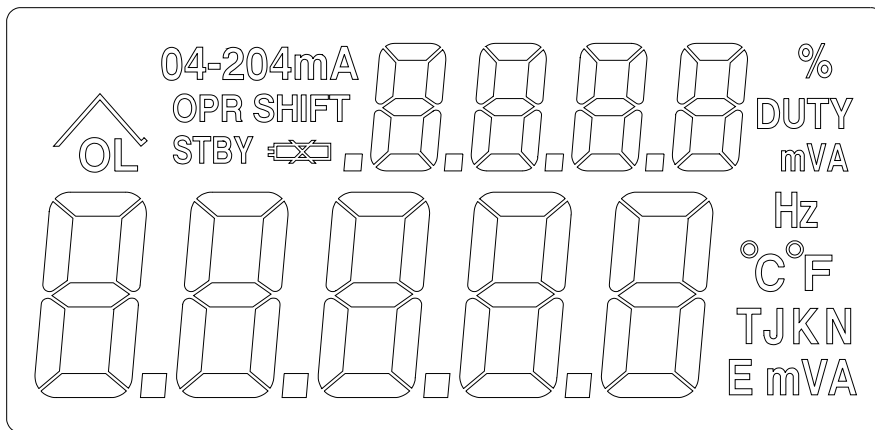

- | | |
|---|---|
| 1.mVAHz: | Units |
| 2.04-204mA : | Range of mA |
| 3. %: | Percentage |
| 4.JKET: | Thermocouple type |
| 5. \wedge : | Ramp |
| 6.OPR : | Operate, Output, Normal |
| 7.OL: | Overload, Output, Abnormal |
| 8.STBY: | Standby, Internal Calibration in Progress |
| 9.SHIFT: | Select SHIFT functions |
| 10.  : | Battery low |



1

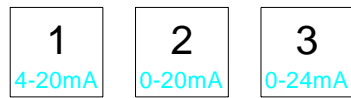

Press SHIFT button, and then press one of these three buttons to select desired mA range

2.

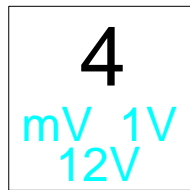

Press SHIFT button, then press this button to select desired mV or V range

3.

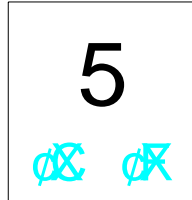

Press SHIFT button, then press this button to select ° C or ° F

4.



Press SHIFT button, then press this button to select desired type of thermocouple.

5.

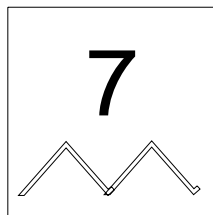

Press SHIFT button, then press this button to perform auto-ramp function. To stop the auto-ramp function, press this button again

6.

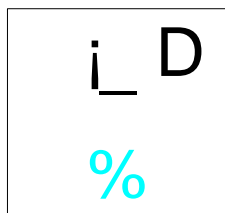

Press this button to enter negative temperature. Or press SHIFT button, then press this button first to enter percentage in the mA, mV, and V functions.

7.

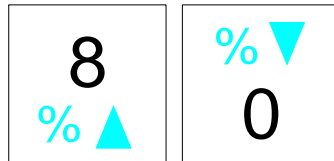

While the calibrator is in the SHIFT mode, and the percentage is entered, press this button to increment %.

8.



Always press this button to complete the entry of numbers.

II. Operating Instruction

1. mA Output

1a. General Operation 4 - 20mA

- 1 Turn the power on, and wait until the STBY symbol disappears (about 1

- min.)
- 2 Plug the test leads into the output connectors of calibrator accordingly (Black to black, red to red). Attach alligator clip if necessary.
 - 3 Move the sliding switch to mA position
 - 4 Press the keypad (including the decimal point) to enter the value of mA directly.
 - 5 Using the test leads or alligator clips, touch or clip on the terminals to be calibrated.

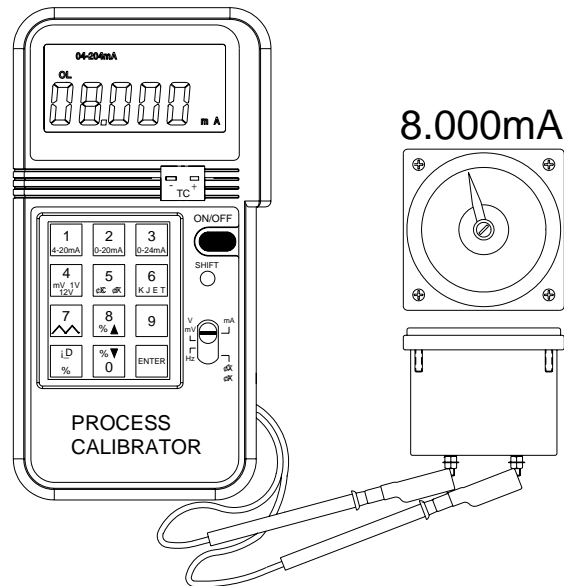

Note: Always waits until STBY (standby) symbol in the LCD disappears before any operation.

Note: Maximum 5 digits can be entered. If users enter less than 5 digits (1 to 4 digits), users must press ENTER button to indicate the end of entry. If users enter 5 or more digits, calibrator will automatically end the entry and output specified value current.

1b. Select 0 - 20mA or 0 - 24mA

The default setting for mA function is 4 - 20mA. But users can select 0 - 20mA or 0 -24 mA by pressing the SHIFT button to enter the SHIFT mode. Then press the NUMBER 2 or NUMBER 3 button to select desired DC current range. After desired range is selected, press the shift button to exit the SHIFT mode. Corresponding current range symbol will be displayed in the LCD.

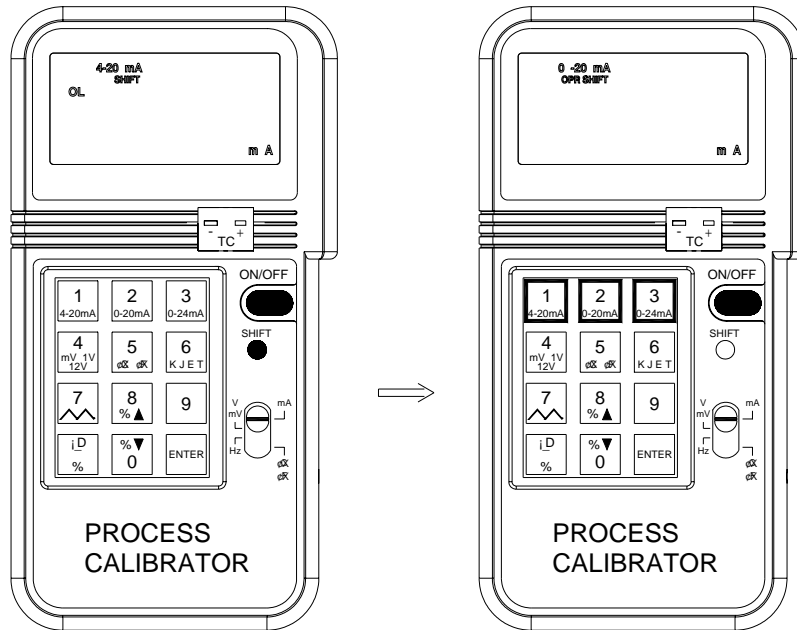

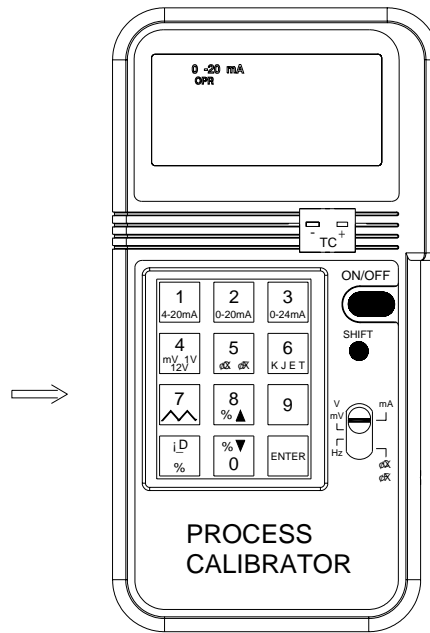

1c. Enter a value less than 1

In the mA functions, the standard way to enter a value less than 1 is to press leading 0 before pressing the decimal point. Though the decimal point can be entered, the decimal point will not be shown in the LCD.

2. mV, V Output

2a. General Operation 0 - 100mV

1. Turn the power on, and wait until the STBY symbol disappears (about 2 min.).
2. Plug the test leads into the output connectors of calibrator accordingly (Black to black, red to red). Attach alligator clip if necessary.
3. Move the sliding switch to mV, V position
4. Press the keypad (including the decimal point) to enter the value of mA directly.
5. Using the test leads or alligator clips, touch or clip on the terminals to be calibrated.

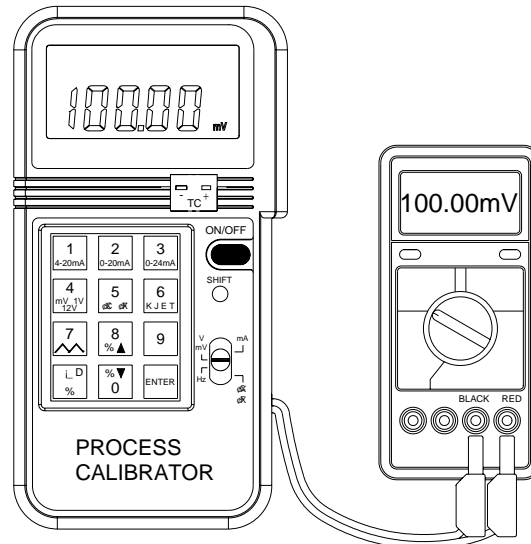

Note: Always wait until STBY (standby) symbol in the LCD to disappear before any operation.

Note: Maximum 5 digits can be entered. If users enter less than 5 digits (1 to 4 digits), users must press ENTER button to indicate the end of entry. If users enter 5 or more digits, calibrator will automatically end the entry and output specified value current.

2b. Select 0 - 1V or 0 - 12V

The default setting for mV, V function is 0 - 100.00mV. Users can select 0 - 1.0000V or 0 - 12.000V by pressing the SHIFT button to enter SHIFT mode. Then press the NUMBER 4 button repeatedly to select desired DC voltage range. After desired range is selected, press the SHIFT button again to exit the SHIFT mode. Corresponding voltage range symbol will be displayed in the LCD.

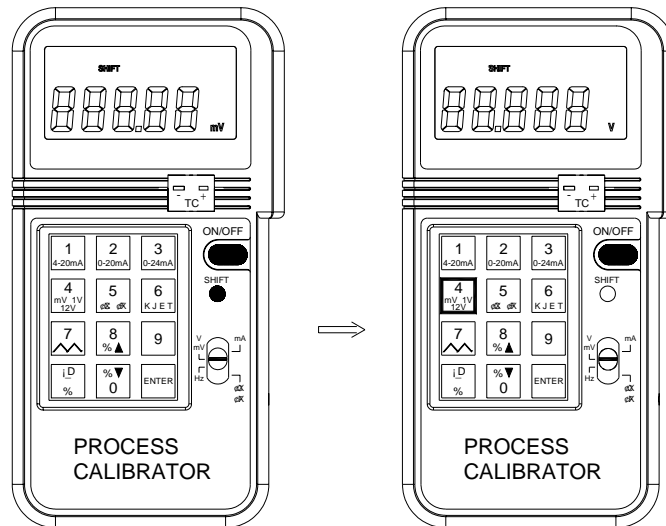

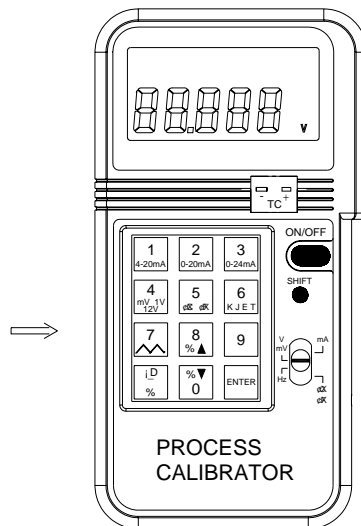

2c. Enter a value less than 1

In the mV/V functions, the standard way to enter a value less than 1 is to press the leading 0 before pressing the decimal point. Though the decimal point can be entered first, the decimal point will not be shown in the LCD.

3. Hz, Frequency Output

1. Turn the power on, then plug the test leads into the output connectors of calibrator accordingly (Black to black, red to red). Attach alligator clip if necessary.
2. Move the sliding switch to Hz position
3. Press the keypad (excluding the decimal point) to enter the value of Hz directly.
4. Using the test leads or alligator clips, touch or clip on the terminals to be calibrated.
5. Because not all the frequencies are available between 126 to 62500Hz, calibrator will automatically adjust and display the users input value to a frequency, which is available and always larger or equal to users input.

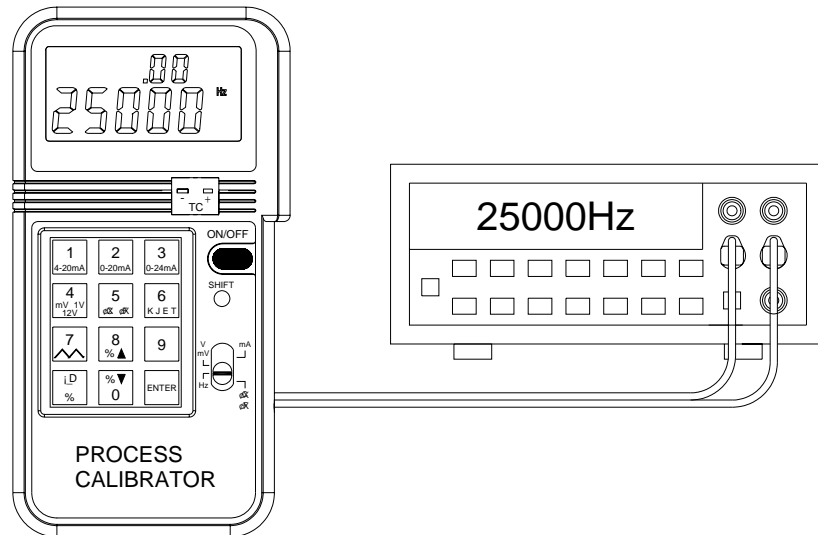

Note: The resolution of Hz function is 1 Hz. For the range 1-125Hz, all the frequencies in between are available. But for the range 126 - 62500Hz, not all the frequencies are available (total 604 frequencies available). Please refer to section III Electrical Specifications for available frequencies.

4. Thermocouple Calibration of °C, °F.

4a. General Operation

1. Turn the power on, and wait until the STBY symbol disappears (about 1 min.).
2. Plug the corresponding connector (K-type connector for K-type thermocouple, J-type connector for J-type thermocouple, ...) into TC terminals of calibrator and thermometer to be calibrated.
3. Move the sliding switch to °C, °F position
4. Press the keypad (including the minus - button) to enter the value of Temperature directly.

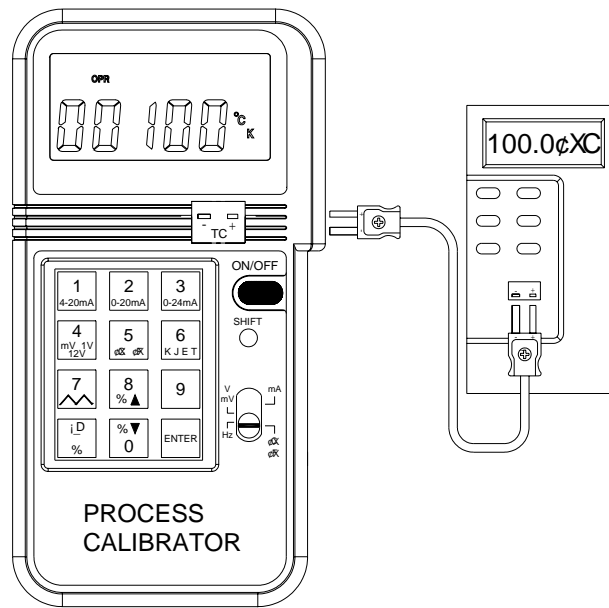

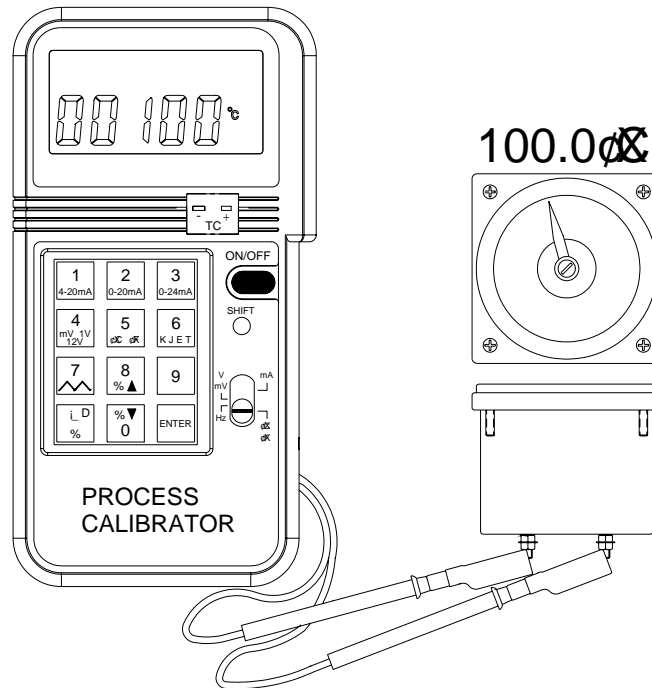

Note: Users can plug the connector into the TC terminals of calibrator even before the power is turned on for better thermal equilibrium between the TC terminal and thermocouple connector.

Note: Only in the °C and °F functions, the negative values are allowed to be entered. To enter negative temperature, press the minus "-" button first.

Note: Maximum 4 digits (including the "-" sign) can be entered. If users enter less than 4 digits (1 to 3 digits), users must press ENTER button to indicate the end of entry. If users enter 4 or more digits, calibrator will automatically end the entry and output specified value of temperature.

4b. Select °C, or °F

Users can select °C or °F by pressing the shift button to enter SHIFT mode. Then press the NUMBER 5 button repeatedly to select desired temperature unit. After desired unit is selected, press the SHIFT button again to exit the SHIFT mode. Corresponding voltage °C or °F symbol will be displayed in the LCD.

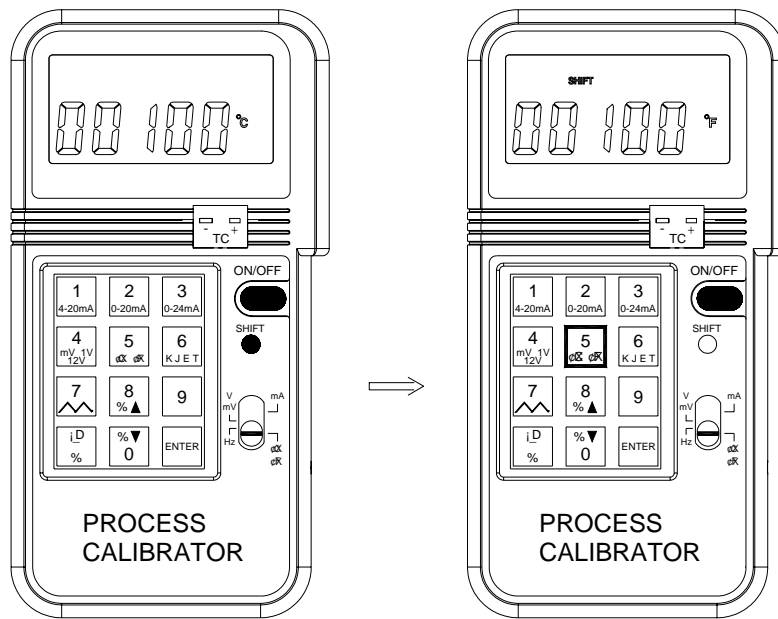

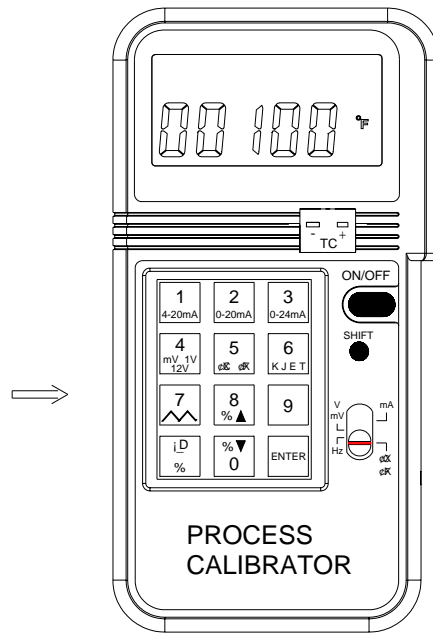

4c. Select K, J, E, or T type Thermocouple

Users can select K, J, E, or T type Thermocouple by pressing the shift button to enter SHIFT mode. Then press the number 6 button repeatedly to select desired type of thermocouple. After desired type is selected, press the shift button again to exit the SHIFT mode. Corresponding thermocouple type (K, J, E, or T) symbol will be displayed in the LCD.

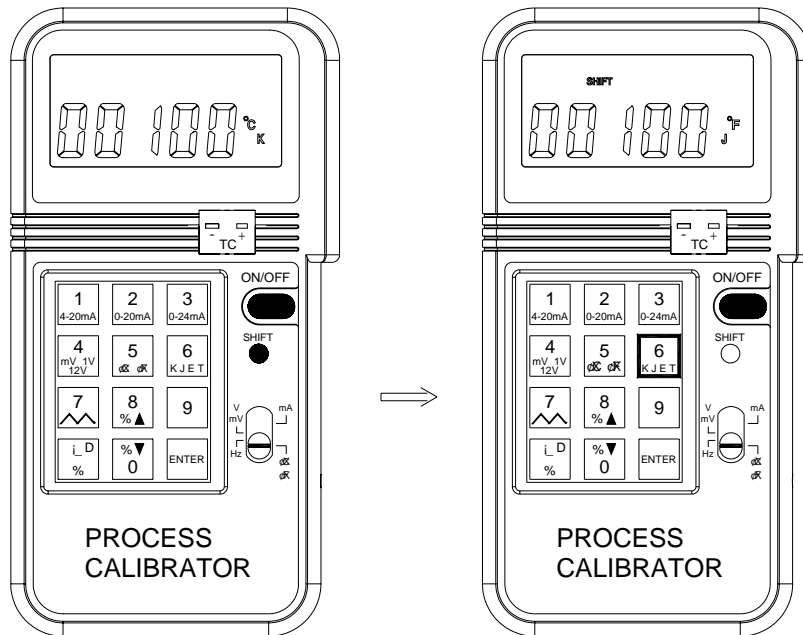

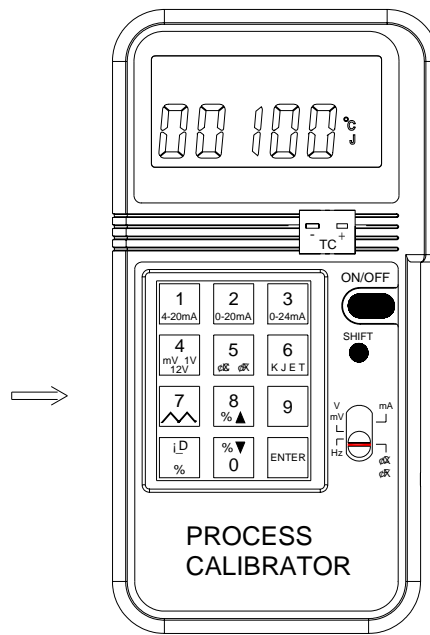

4d. Enter a Negative Temperature

The resolution of temperature is 1 degree, so the decimal point is used a minus "-" sign. To enter a negative temperature, press the "-" button first.

5. % input in the mA, mV, V functions

In the mA, mV, or V function, users can enter percentage. To enter percentage (%)

1. Users press the shift button first, then SHIFT symbol will be displayed in the LCD.
2. Press % button first, then press the number (no decimal number, the % resolution is 1%).
3. After percentage is entered, the percentage will be displayed in the upper LCD, and the corresponding value will be displayed in the lower LCD.
4. The corresponding value is calculated based upon the range selected.

4-20mA:	1% = 0.16mA
0-20mA:	1% = 0.2mA
0-24mA:	1% = 0.24mA
0-100mV:	1% = 1mV
0-1V:	1% = 0.01V
0-12V:	1% = 0.12V

5. To exit the percentage-input mode, press the SHIFT button again.
6. After the SHIFT button is pressed, the upper LCD will become blank, while the lower LCD retains its last value.

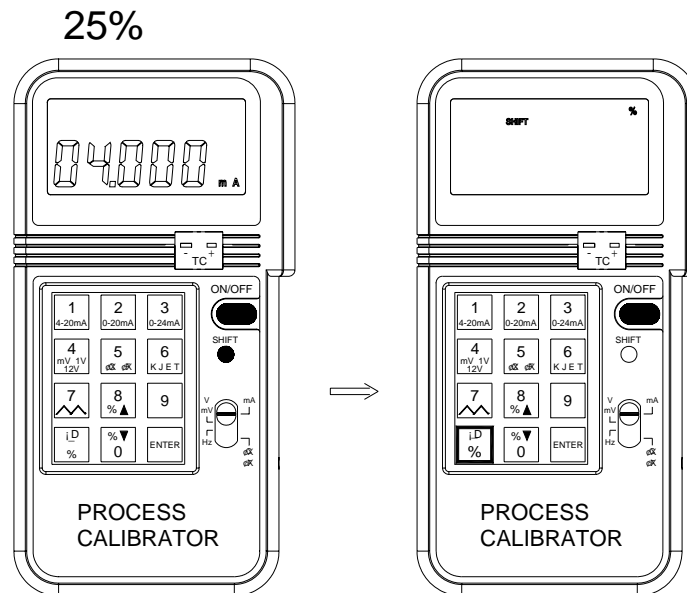

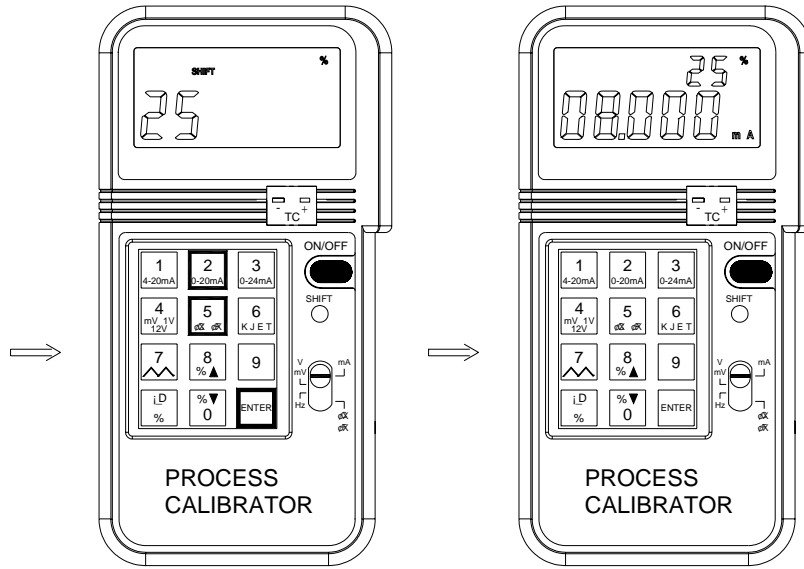

6. Easy Step in the mA, mV, and V Functions

While the percentage is entered and calibrator is still in the SHIFT mode, users can step up or down by the percentage entered. The maximum percentage is 100% while the minimum percentage is 0%. If the next step up or down exceeds the maximum or minimum percentage, the percentage will stay in the previous step.

Example 1: Step Up and Down(25%):

25% -> 50% -> 75% -> 100% -> 75% -> 50% -> 25% -> 0% -> 25%

Example 2: Step Up and Down(30%):

30% -> 60% -> 90% -> 60% -> 30% -> 0% -> 30%

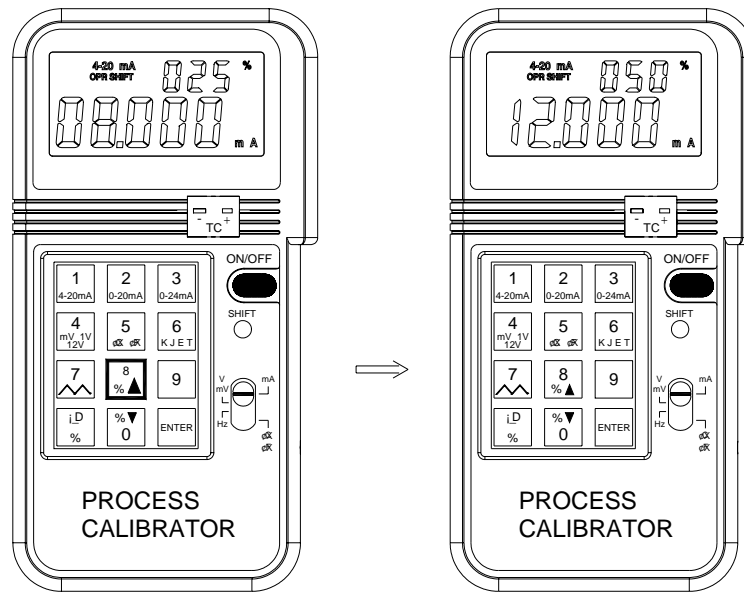

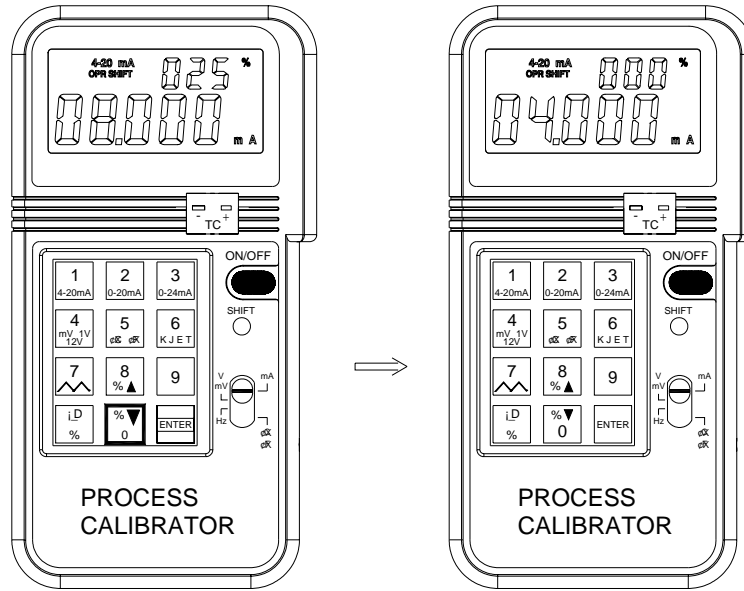

7. Auto Ramp in the mA, mV, and V functions

In the mA, mV, and V function, auto ramp function is available to the users. To start the ramp function:

1. Press the SHIFT button to enter the SHIFT mode.
2. Press the NUMBER 7 key to start
3. Ramp function increment from 0% to 100%, then decrements from 100% to 0% repeatedly. The resolution of each step is 1% (with respect the range selected) at an interval of 0.08 seconds. So it takes 8 seconds to ramp from 0 to 100%.
4. To temporarily stop the ramp function, press the NUMBER 7 key, and the output will stay at the value when the NUMBER 7 key is pressed. These features will facilitate the checking of trigger point of tested device, such as valve controller.
5. To restart again, press the NUMBER 7 button again.
6. To return to the regular output mode, press the SHIFT button again when ramp function is stopped.

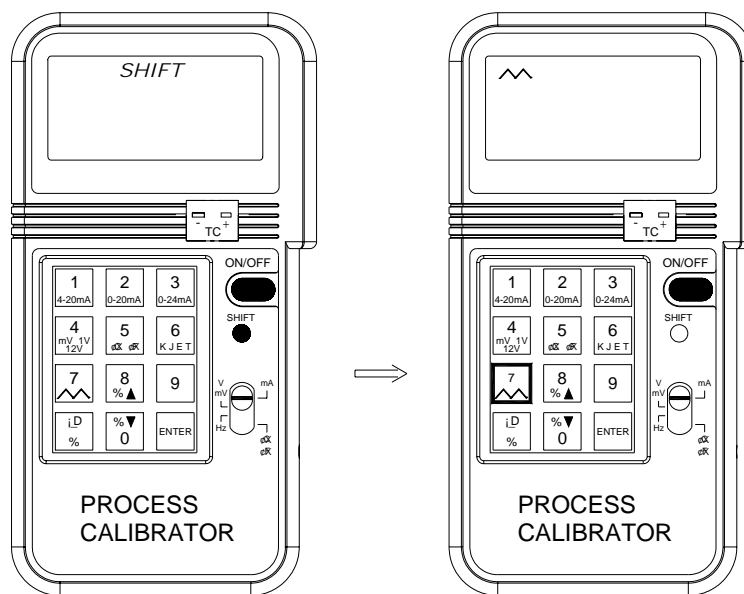

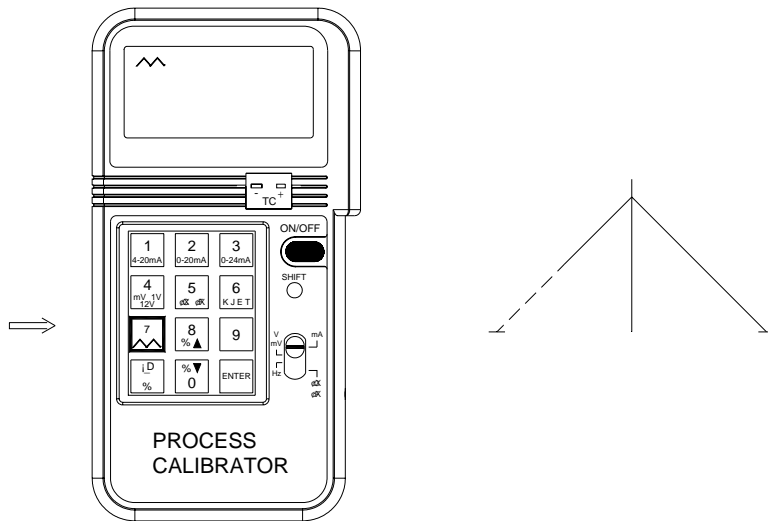
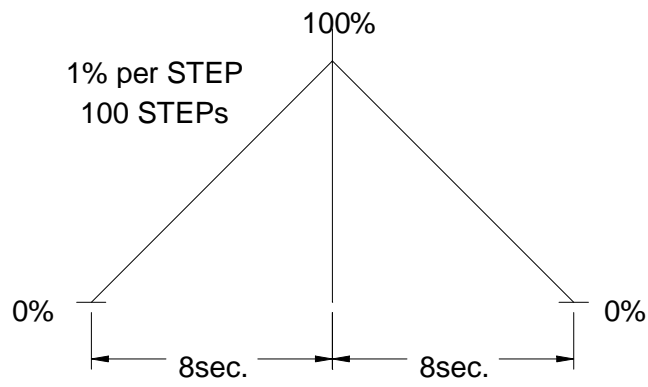

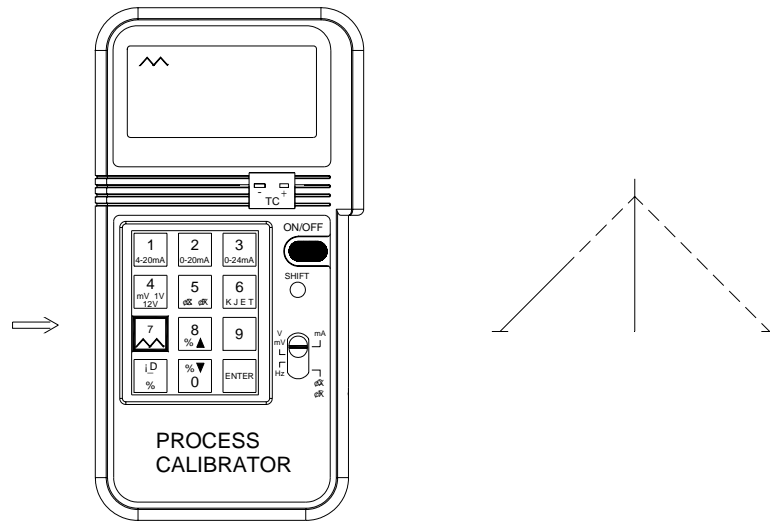

Note: Do not press any button while the calibrator is performing the ramp function (except NUMBER 7 button to stop the ramp function).

8. How to Get Negative Output

If negative output (mA, mV, or V) is needed, users can achieve it by interchange the connection of test leads.

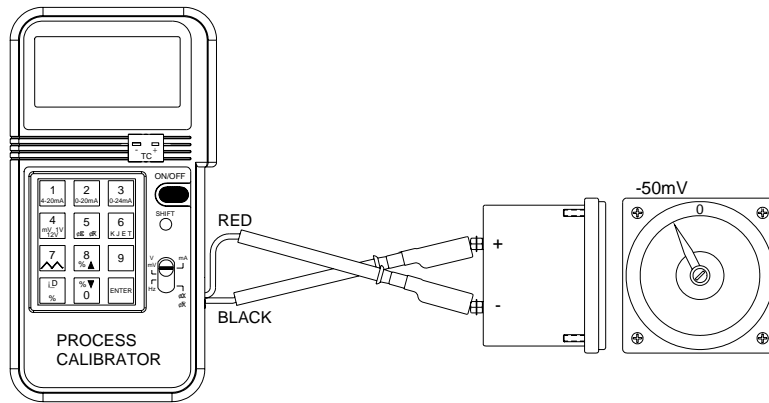
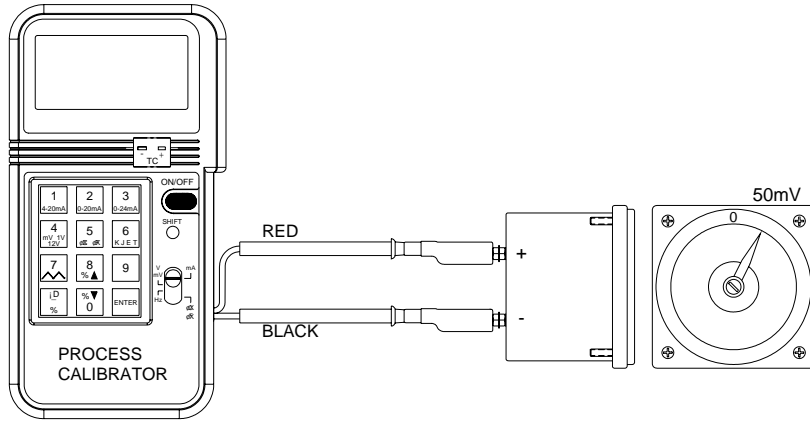

III. Electrical Specification (23°C ± 5°C, 5 minutes after power is on)

mA DC Current (1K Ω Max. Load, 24V Loop Supply)

Range	Resolution	Accuracy
4 - 20mA, 0 - 20mA, 0 -24 mA	1 μ A	$\pm 0.025\% \pm 3\mu$ A

Beeper warning when output is open and specified current output > 1mA

mV, V DC Voltage (1mA Supply Current)

Range	Resolution	Accuracy
0 - 100.00mV	10 μ V	$\pm 0.05\% \pm 30\mu$ V
0 - 10.000V	1mV	$\pm 0.05\% \pm 3$ mV
0 - 1.0000V	100 μ V	$\pm 0.05\% \pm 300\mu$ V

Beeper warning when output is short and specified voltage output > 10mV

K, J, E, T type Thermocouples(1°C,1°F Resolution,1K Ω load Min.)

Range	Accuracy	Range	Accuracy
K: -200 to 0 °C	$\pm 1.1^\circ$ C	K: -328 to 32°F	$\pm 2.0^\circ$ F
K: 0 to 1370 °C	$\pm 0.8^\circ$ C	K: 32 to 2400°F	$\pm 1.5^\circ$ F
J: -100 to 0 °C	$\pm 0.9^\circ$ C	J: -148 to 32°F	$\pm 1.6^\circ$ F
J: 0 to 760 °C	$\pm 0.7^\circ$ C	J: 32 to 1400°F	$\pm 1.2^\circ$ F
E: -100 to 0 °C	$\pm 0.9^\circ$ C	E: -148 to 32°F	$\pm 1.6^\circ$ F
E: 0 to 700 °C	$\pm 0.7^\circ$ C	E: 32 to 1292°F	$\pm 1.2^\circ$ F
T: -200 to 0 °C	$\pm 1.0^\circ$ C	T: -328 to 32°F	$\pm 1.8^\circ$ F
T: 0 to 400 °C	$\pm 0.8^\circ$ C	T: 32 to 752°F	$\pm 1.5^\circ$ F

Frequency (1 - 125Hz, 1K Ω Load Min.)

Range	Resolution	Accuracy
1 - 125 Hz	1 Hz	± 0.04 Hz

Available Frequencies

(126 - 62500Hz, Accuracy $\pm 0.01\% \pm 0.04$ Hz, 1K Ω Load Min):

126.00	127.03	128.07	129.13	130.20	131.30	132.41	133.54
134.12	135.28	136.46	137.06	138.27	139.50	140.13	141.40
142.04	143.34	144.00	145.34	146.02	147.40	148.10	149.52
150.24	151.69	152.43	153.18	154.70	155.47	156.25	157.03
158.62	159.43	160.25	161.08	162.76	163.61	164.47	165.34
166.22	167.11	168.01	169.83	170.76	171.70	172.65	173.61
174.58	175.56	176.55	177.55	178.57	179.59	180.63	181.68
182.74	183.82	184.91	186.01	187.12	188.25	189.39	190.54
191.71	192.90	194.09	195.31	196.54	197.78	199.04	200.32
201.61	202.92	204.24	205.59	206.95	208.33	209.73	211.14
212.58	214.04	215.51	217.01	218.53	220.07	221.63	223.21
224.82	226.44	228.10	229.77	231.48	233.20	234.96	236.74
238.54	240.38	242.24	244.14	246.06	248.01	250.00	252.01
254.06	256.14	258.26	260.41	262.60	264.83	267.09	269.39
271.73	274.12	276.54	279.01	281.53	284.09	286.69	289.35
292.05	294.81	297.61	300.48	303.39	306.37	309.40	312.50
315.65	318.87	322.16	325.52	328.94	332.44	336.02	339.67
343.40	347.22	351.12	355.11	359.19	363.37	367.64	372.02
376.50	381.09	385.80	390.62	395.56	400.64	405.84	411.18
416.66	422.29	428.08	434.02	440.14	446.42	452.89	459.55
466.41	473.48	480.76	488.28	490.19	492.12	494.07	496.03
498.00	500.00	502.00	504.03	506.07	508.13	510.20	512.29
514.40	516.52	518.67	520.83	523.01	525.21	527.42	529.66
531.91	534.18	536.48	538.79	541.12	543.47	545.85	548.24
550.66	553.09	555.55	558.03	560.53	563.06	565.61	568.18

570.77	573.39	576.03	578.70	581.39	584.11	586.85	589.62
592.41	595.23	598.08	600.96	603.86	606.79	609.75	612.74
615.76	618.81	621.89	625.00	628.14	631.31	634.51	637.75
641.02	644.32	647.66	651.04	654.45	657.89	661.37	664.89
668.44	672.04	675.67	679.34	683.06	686.81	690.60	694.44
698.32	702.24	706.21	710.22	714.28	718.39	722.54	726.74
730.99	735.29	739.64	744.04	748.50	753.01	757.57	762.19
766.87	771.60	776.39	781.25	786.16	791.13	796.17	801.28
806.45	811.68	816.99	822.36	827.81	833.33	838.92	844.59
850.34	856.16	862.06	868.05	874.12	880.28	886.52	892.85
899.28	905.79	912.40	919.11	925.92	932.83	939.84	946.96
954.19	961.53	968.99	976.56	984.25	992.06		
1000.00	1008.06	1016.26	1024.59	1033.05	1041.66	1050.42	1059.32
1068.37	1077.58	1086.95	1096.49	1106.19	1116.07	1126.12	1136.36
1146.78	1157.40	1168.22	1179.24	1190.47	1201.92	1213.59	1225.49
1237.62	1250.00	1262.62	1275.51	1288.65	1302.08	1315.78	1329.78
1344.08	1358.69	1373.62	1388.88	1404.49	1420.45	1436.78	1453.48
1470.58	1488.09	1506.02	1524.39	1543.20	1562.50	1582.27	1602.56
1623.37	1644.73	1666.66	1689.18	1712.32	1736.11	1760.56	1785.71
1811.59	1838.23	1865.67	1893.93	1923.07	1953.12	1960.78	1968.50
1976.28	1984.12	1992.03	2000.00	2008.03	2016.12	2024.29	2032.52
2040.81	2049.18	2057.61	2066.11	2074.68	2083.33	2092.05	2100.84
2109.70	2118.64	2127.65	2136.75	2145.92	2155.17	2164.50	2173.91
2183.40	2192.98	2202.64	2212.38	2222.22	2232.14	2242.15	2252.25
2262.44	2272.72	2283.10	2293.57	2304.14	2314.81	2325.58	2336.44
2347.41	2358.49	2369.66	2380.95	2392.34	2403.84	2415.45	2427.18
2439.02	2450.98	2463.05	2475.24	2487.56	2500.00	2512.56	2525.25
2538.07	2551.02	2564.10	2577.31	2590.67	2604.16	2617.80	2631.57
2645.50	2659.57	2673.79	2688.17	2702.70	2717.39	2732.24	2747.25
2762.43	2777.77	2793.29	2808.98	2824.85	2840.90	2857.14	2873.56
2890.17	2906.97	2923.97	2941.17	2958.57	2976.19	2994.01	3012.04
3030.30	3048.78	3067.48	3086.41	3105.59	3125.00	3144.65	3164.55
3184.71	3205.12	3225.80	3246.75	3267.97	3289.47	3311.25	3333.33
3355.70	3378.37	3401.36	3424.65	3448.27	3472.22	3496.50	3521.12

3546.09	3571.42	3597.12	3623.18	3649.63	3676.47	3703.70	3731.34
3759.39	3787.87	3816.79	3846.15	3875.96	3906.25	3937.00	3968.25
4000.00	4032.25	4065.04	4098.36	4132.23	4166.66	4201.68	4237.28
4273.50	4310.34	4347.82	4385.96	4424.77	4464.28	4504.50	4545.45
4587.15	4629.62	4672.89	4716.98	4761.90	4807.69	4854.36	4901.96
4950.49	5000.00	5050.50	5102.04	5154.63	5208.33	5263.15	5319.14
5376.34	5434.78	5494.50	5555.55	5617.97	5681.81	5747.12	5813.95
5882.35	5952.38	6024.09	6097.56	6172.83	6250.00	6329.11	6410.25
6493.50	6578.94	6666.66	6756.75	6849.31	6944.44	7042.25	7142.85
7246.37	7352.94	7462.68	7575.75	7692.30	7812.50	7936.50	8064.51
8196.72	8333.33	8474.57	8620.68	8771.92	8928.57	9090.90	9259.25
9433.96	9615.38	9803.92					
10000.00	10204.08	10416.66	10638.29	10869.56	11111.11	11363.63	11627.90
11904.76	12195.12	12500.00	12820.51	13157.89	13513.51	13888.88	14285.71
14705.88	15151.51	15625.00	16129.03	16666.66	17241.37	17857.14	18518.51
19230.76	20000.00	20833.33	21739.13	22727.27	23809.52	25000.00	26315.78
27777.77	29411.76	31250.00	33333.33	35714.28	38461.53	41666.66	45454.54
50000.00	55555.55	62500.00					

General Specification:

Battery Type:	9V Alkaline Battery
Power Consumption:	60mA - 180mA (depends on output)
Low battery:	5.5V at 150mA Load
Display:	4 and 5 Digits
Operating Temperature:	0 to 50°C (32 to 122 °F)
Operating Humidity:	Less than 85% relative
Storage Temperature:	-20 to 60° C (-4 to 140 °F)
Storage Humidity:	Less than 85% relative
Dimension:	88 x 168 x 26 mm (3.46" x 6.61" x 1.03")
Weight:	330 g / 11.63 oz
Accessories:	Carrying case x 1 Users Manual x 1 K type thermocouple connector External Battery Pack Holder 1.5V AA Batteries x 6 Test leads with Alligator clip x 1

IV. Use the AC adapter

If long term usage of the calibrator is required, AC adapter can be used. The 12V AC terminal is located in the back of the calibrator. The voltage should be regulated between 9 to 15V.

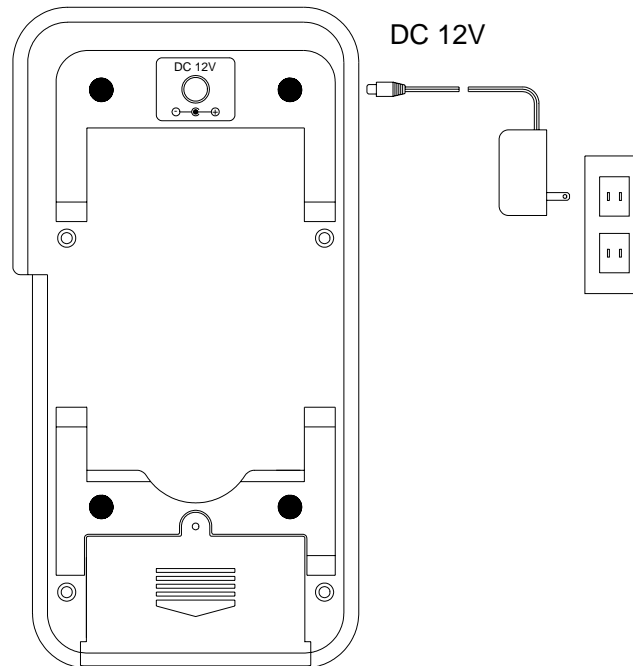

V. Use External Battery Pack

An external battery pack is included for a longer period usage. The external battery pack needs to be packed with 6 pieces of 1.5 volts AA batteries. To use the external battery pack, plug into the AC terminals located in the back of the calibrator.

BATTERY HOLDER

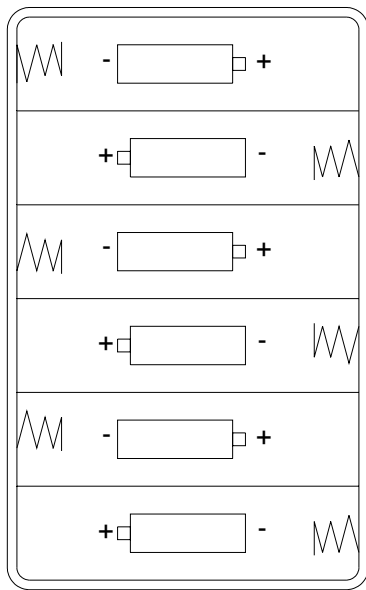

BATTERIES 6x1.5V AA

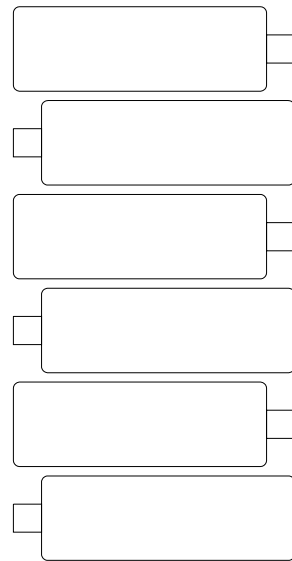

VI. Battery Replacement

When the low battery symbol is displayed on LCD, follow the following procedures to replace the battery.

- 1 Turn off the calibrator by pushing the On/Off button.
- 2 Remove the screw of the battery compartment cover and remove the battery compartment cover.
- 3 Replace the old 9V battery with a new alkaline 9V battery.
- 4 Replace the battery compartment cover and fasten the screw.

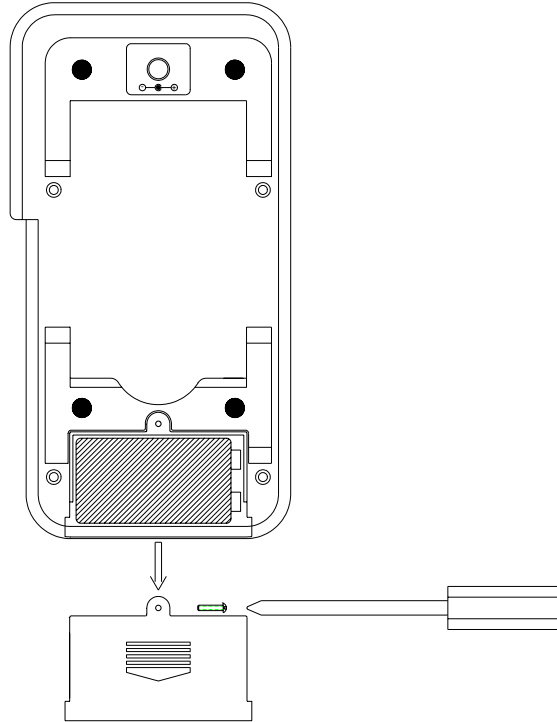

Note: In the mA, mV, V, 0°C, and °F functions, status of low battery is detected. While in the Hz function, status of low battery is not detected.